

HIGHLIGHTS OF PRESCRIBING INFORMATION

These highlights do not include all the information needed to use SEEBRI NEOHALER safely and effectively. See full prescribing information for SEEBRI NEOHALER.

SEEBRI™ NEOHALER® (glycopyrrolate) inhalation powder, for oral inhalation use

Initial U.S. Approval: 1961

INDICATIONS AND USAGE

SEEBRI NEOHALER is an anticholinergic indicated for the long-term, maintenance treatment of airflow obstruction in patients with chronic obstructive pulmonary disease (COPD) (1)

DOSAGE AND ADMINISTRATION

- For oral inhalation only. Do not swallow SEEBRI capsules. Only use SEEBRI capsules with the NEOHALER device. (2)
- Maintenance treatment of COPD: The inhalation of the powder contents of one SEEBRI capsule (15.6 mcg) twice-daily (2)

DOSAGE FORMS AND STRENGTHS

- Inhalation powder: SEEBRI capsules contain 15.6 mcg of glycopyrrolate inhalation powder for use with the NEOHALER device (3)

CONTRAINDICATIONS

- History of known hypersensitivity to glycopyrrolate or to any of the ingredients. (4, 5.3)

WARNINGS AND PRECAUTIONS

- Do not initiate in acutely deteriorating COPD or to treat acute symptoms. (5.1)

- If paradoxical bronchospasm occurs, discontinue SEEBRI NEOHALER immediately and institute alternative therapy. (5.2)
- Worsening of narrow-angle glaucoma may occur. Use with caution in patients with narrow-angle glaucoma and instruct patients to contact a physician immediately if symptoms occur. (5.4)
- Worsening of urinary retention may occur. Use with caution in patients with prostatic hyperplasia or bladder neck obstruction and instruct patients to consult a physician immediately if symptoms occur. (5.5)

ADVERSE REACTIONS

Most common adverse reactions (incidence greater than or equal to 2% and higher than placebo) are upper respiratory tract infection and nasopharyngitis. (6.1)

To report SUSPECTED ADVERSE REACTIONS, contact Novartis Pharmaceuticals Corporation at 1-888-669-6682 or FDA at 1-800-FDA-1088 or www.fda.gov/medwatch.

DRUG INTERACTIONS

- Anticholinergics: May interact additively with concomitantly used anticholinergic medications. Avoid administration of SEEBRI NEOHALER with other anticholinergic-containing drugs. (7.2)

USE IN SPECIFIC POPULATIONS

- Use in patients with severe renal impairment should be considered if the potential benefit of the treatment outweighs the risk. (8.6)

See 17 for PATIENT COUNSELING INFORMATION and FDA-approved patient labeling.

Revised: 10/2015

FULL PRESCRIBING INFORMATION: CONTENTS*

1	INDICATIONS AND USAGE	8.4	Pediatric Use
2	DOSAGE AND ADMINISTRATION	8.5	Geriatric Use
3	DOSAGE FORMS AND STRENGTHS	8.6	Renal Impairment
4	CONTRAINDICATIONS	8.7	Hepatic Impairment
5	WARNINGS AND PRECAUTIONS	10	OVERDOSAGE
5.1	Deterioration of Disease and Acute Episodes	11	DESCRIPTION
5.2	Paradoxical Bronchospasm	12	CLINICAL PHARMACOLOGY
5.3	Immediate Hypersensitivity Reactions	12.1	Mechanism of Action
5.4	Worsening of Narrow-Angle Glaucoma	12.2	Pharmacodynamics
5.5	Worsening of Urinary Retention	12.3	Pharmacokinetics
6	ADVERSE REACTIONS	13	NONCLINICAL TOXICOLOGY
6.1	Clinical Trials Experience	13.1	Carcinogenesis, Mutagenesis, Impairment of Fertility
6.2	Postmarketing Experience	14	CLINICAL STUDIES
7	DRUG INTERACTIONS	14.1	Dose Ranging Trial
7.1	Sympathomimetics, Methylxanthines, Steroids	14.2	Confirmatory Trials
7.2	Anticholinergics	16	HOW SUPPLIED/STORAGE AND HANDLING
8	USE IN SPECIFIC POPULATIONS	17	PATIENT COUNSELING INFORMATION
8.1	Pregnancy		
8.2	Labor and Delivery		
8.3	Nursing Mothers		

*Sections or subsections omitted from the full prescribing information are not listed.

FULL PRESCRIBING INFORMATION

1 INDICATIONS AND USAGE

SEEBRI™ NEOHALER® is indicated for the long-term, maintenance treatment of airflow obstruction in patients with chronic obstructive pulmonary disease (COPD), including chronic bronchitis and/or emphysema.

2 DOSAGE AND ADMINISTRATION

For oral inhalation only. Do not swallow SEEBRI capsules, as the intended effects on the lungs will not be obtained. SEEBRI capsules should only be used with the NEOHALER device [see *Overdosage (10)*].

The recommended dose of SEEBRI NEOHALER is the inhalation of the contents of one SEEBRI capsule twice-daily using the SEEBRI NEOHALER device.

SEEBRI NEOHALER should be administered at the same time of the day, (1 capsule in the morning and 1 capsule in the evening), every day. More frequent administration or a greater number of inhalations (more than 1 capsule twice-daily) of SEEBRI NEOHALER is not recommended.

Store SEEBRI capsules in the blister, and only remove IMMEDIATELY BEFORE USE with the NEOHALER device.

No dosage adjustment is required for geriatric patients, patients with hepatic impairment, or patients with mild to moderate renal impairment.

3 DOSAGE FORMS AND STRENGTHS

Inhalation powder: SEEBRI NEOHALER consists of SEEBRI capsules containing glycopyrrolate powder for oral inhalation and the NEOHALER device. SEEBRI capsules contain 15.6 mcg of glycopyrrolate in an orange transparent hypromellose (HPMC) capsule with the product code “GPL15.6” printed in black and the logo () printed with two radial black bars.

4 CONTRAINDICATIONS

SEEBRI NEOHALER is contraindicated in patients who have demonstrated hypersensitivity to glycopyrrolate or to any of the ingredients [see *Warnings and Precautions (5.3)*].

5 WARNINGS AND PRECAUTIONS

5.1 Deterioration of Disease and Acute Episodes

SEEBRI NEOHALER should not be initiated in patients during acutely deteriorating or potentially life-threatening episodes of COPD. SEEBRI NEOHALER has not been studied in subjects with acutely deteriorating COPD. The initiation of SEEBRI NEOHALER in this setting is not appropriate.

SEEBRI NEOHALER should not be used for the relief of acute symptoms, i.e., as rescue therapy for the treatment of acute episodes of bronchospasm. SEEBRI NEOHALER has not been studied in the relief of acute symptoms and extra doses should not be used for that purpose. Acute symptoms should be treated with an inhaled, short-acting beta₂-agonist.

COPD may deteriorate acutely over a period of hours or chronically over several days or longer. If SEEBRI NEOHALER no longer controls symptoms of bronchoconstriction; the patient's inhaled, short-acting beta₂-agonist becomes less effective; or the patient needs more inhalation of a short-acting beta₂-agonist than usual, these may be markers of deterioration of disease. In this setting, a re-evaluation of the patient and the COPD treatment regimen should be undertaken at once. Increasing the daily dose of SEEBRI NEOHALER beyond the recommended dose is not appropriate in this situation.

5.2 Paradoxical Bronchospasm

As with other inhaled medicines, SEEBRI NEOHALER can produce paradoxical bronchospasm that may be life-threatening. If paradoxical bronchospasm occurs following dosing with SEEBRI NEOHALER, it should be treated immediately with an inhaled, short-acting bronchodilator; SEEBRI NEOHALER should be discontinued immediately, and alternative therapy instituted.

5.3 Immediate Hypersensitivity Reactions

Immediate hypersensitivity reactions have been reported after administration of SEEBRI NEOHALER. If signs suggesting allergic reactions occur, in particular, angioedema (including difficulties in breathing or swallowing, swelling of the tongue, lips, and face), urticaria, or skin rash, SEEBRI NEOHALER should be discontinued immediately and alternative therapy instituted. SEEBRI NEOHALER should be used with caution in patients with severe hypersensitivity to milk proteins.

5.4 Worsening of Narrow-Angle Glaucoma

SEEBRI NEOHALER should be used with caution in patients with narrow-angle glaucoma. Prescribers and patients should be alert for signs and symptoms of acute narrow-angle glaucoma (e.g., eye pain or discomfort, blurred vision, visual halos or colored images in association with red eyes from conjunctival congestion and corneal edema). Instruct patients to consult a physician immediately should any of these signs or symptoms develop.

5.5 Worsening of Urinary Retention

SEEBRI NEOHALER should be used with caution in patients with urinary retention. Prescribers and patients should be alert for signs and symptoms of urinary retention (e.g., difficulty passing urine, painful urination), especially in patients with prostatic hyperplasia or bladder-neck obstruction. Instruct patients to consult a physician immediately should any of these signs or symptoms develop.

6 ADVERSE REACTIONS

The following adverse reactions are described in greater detail, in other sections

- Paradoxical bronchospasm [*see Warnings and Precautions (5.2)*].
- Immediate hypersensitivity reactions [*see Warnings and Precautions (5.3)*].
- Worsening of narrow-angle glaucoma [*see Warnings and Precautions (5.4)*].
- Worsening of urinary retention [*see Warnings and Precautions (5.5)*].

6.1 Clinical Trials Experience

Because clinical trials are conducted under widely varying conditions, the adverse reaction rates observed in the clinical trials of a drug cannot be directly compared to rates in clinical trials of another drug and may not reflect the rates observed in clinical practice.

The SEEBRI NEOHALER safety database included 3415 subjects with COPD in four 12-week lung function trials and one 52-week long-term safety study. A total of 1202 subjects received treatment with SEEBRI NEOHALER 15.6 mcg twice-daily (BID). The safety data described below are based on the four 12-week trials and the one 52-week trial.

12-Week Trials

The incidence of adverse reactions associated with SEEBRI NEOHALER in Table 1 is based on four 12-week, placebo-controlled trials in 2908 subjects with COPD. In the total population, 61.2% of patients had moderate COPD and 37.8% had severe COPD. In these trials, 951 subjects received SEEBRI NEOHALER 15.6 mcg BID, 511 subjects received indacaterol 27.5 mcg BID, 508 subjects received a fixed-dose combination of indacaterol/glycopyrrolate 27.5 mcg/15.6 mcg BID, and 938 subjects received placebo. Overall, 62% were males, 90% were Caucasian, and the mean age was 63 years (ranging from 41 to 89 years). In this population, 53% were identified as current smokers with an average smoking history of 48 pack-years.

The most common adverse reactions (incidence greater than or equal to 2% and higher than placebo) were upper respiratory tract infection and nasopharyngitis.

The proportion of subjects who discontinued treatment due to adverse reactions was 2.4% for the SEEBRI NEOHALER-treated patients and 3.8% for placebo-treated patients.

Table 1. Adverse reactions with SEEBRI NEOHALER (greater than or equal to 1% incidence and higher than placebo) in COPD patients

Adverse Reaction	SEEBRI NEOHALER 15.6 mcg BID	Placebo
	(N=951) n (%)	(N=938) n (%)
Upper respiratory tract infection	32 (3.4)	22 (2.3)
Nasopharyngitis	20 (2.1)	18 (1.9)
Urinary tract infection	13 (1.4)	12 (1.3)
Sinusitis	13 (1.4)	7 (0.7)
Oropharyngeal pain	17 (1.8)	11 (1.2)

Other adverse reactions occurring more frequently with SEEBRI NEOHALER than with placebo, but with an incidence of less than 1% include rash, pruritus, gastroenteritis, hypersensitivity, atrial fibrillation, insomnia, pain in extremity, dysuria, vomiting, productive cough, and diabetes mellitus/hyperglycemia.

52-Week Trial

In a long-term safety trial, 507 subjects were treated for up to 52 weeks with glycopyrrolate 15.6 mcg twice-daily or indacaterol 75 mcg once-daily. The demographic and baseline characteristics of the long-term safety trial were similar to those of the placebo-controlled efficacy trials described above. The adverse reactions reported in the long-term safety trial were consistent with those observed in the placebo-controlled trials of 12 weeks. Additional adverse reactions that occurred with a frequency greater than or equal to 2% in the group receiving glycopyrrolate 15.6 mcg twice-daily that exceeded the frequency of indacaterol 75 mcg once-daily in this trial were: diarrhea, nausea, upper abdominal pain, fatigue, bronchitis, pneumonia, rhinitis, back pain, arthralgia, dyspnea, and wheezing.

6.2 Postmarketing Experience

The following additional adverse reactions have been identified during worldwide post-approval use of glycopyrrolate, the active ingredient in SEEBRI NEOHALER, at higher than the recommended dose. Because these reactions are reported voluntarily from a population of uncertain size, it is not always possible to reliably estimate their frequency or establish a causal relationship to drug exposure. These adverse reactions are: angioedema and paradoxical bronchospasm.

7 DRUG INTERACTIONS

7.1 Sympathomimetics, Methylxanthines, Steroids

In clinical studies, concurrent administration of short-acting and long-acting sympathomimetic (beta-agonists) bronchodilators (including indacaterol), methylxanthines, oral and inhaled steroids with SEEBRI NEOHALER showed no increases in adverse drug reactions.

7.2 Anticholinergics

There is a potential for an additive interaction with concomitantly used anticholinergic medications. Therefore, avoid coadministration of SEEBRI NEOHALER with other anticholinergic-containing drugs as this may lead to an increase in anticholinergic effects [*see Warnings and Precautions (5.4, 5.5) and Adverse Reactions (6)*].

8 USE IN SPECIFIC POPULATIONS

8.1 Pregnancy

Teratogenic Effects: Pregnancy Category C

There are no adequate and well-controlled studies with SEEBRI NEOHALER in pregnant women. Because animal reproduction studies are not always predictive of human response, SEEBRI NEOHALER should only be used during pregnancy if the potential benefit to the patient justifies the potential risk to the fetus. Women should be advised to contact their physician if they become pregnant while taking SEEBRI NEOHALER.

Glycopyrrolate was not teratogenic in Wistar rats and New Zealand White rabbits at approximately 1400 and 530 times, respectively, the MRHD in adults (on an AUC basis at maternal inhaled doses up to 3.83 mg/kg/day in rats and up to 4.4 mg/kg/day in rabbits).

Non-teratogenic Effects:

Glycopyrrolate had no effects on peri-natal and post-natal developments in rats at approximately 1100 times the MRHD in adults (on an AUC basis at maternal subcutaneous doses up to 1.88 mg/kg/day).

8.2 Labor and Delivery

There are no adequate and well-controlled human trials that have investigated the effects of SEEBRI NEOHALER during labor and delivery. In human parturients undergoing caesarean section, 86 minutes after a single intramuscular injection of 0.006 mg/kg glycopyrrolate, umbilical plasma concentrations were low.

8.3 Nursing Mothers

It is not known whether SEEBRI NEOHALER is excreted in human breast milk. Because many drugs are excreted in human milk, caution should be exercised when SEEBRI NEOHALER is administered to a nursing woman. Since there are no data from well-controlled human studies on the use of SEEBRI NEOHALER by nursing mothers, a decision should be made whether to discontinue nursing or to discontinue SEEBRI NEOHALER, taking into account the importance of SEEBRI NEOHALER to the mother.

It is not known whether glycopyrrolate is excreted in human breast milk. Glycopyrrolate (including its metabolites) have been detected in the milk of lactating rats and reached up to 10-fold higher concentrations in the milk than in the blood of the dam.

8.4 Pediatric Use

SEEBRI NEOHALER is not indicated for use in children. The safety and efficacy of SEEBRI NEOHALER in pediatric patients have not been established.

8.5 Geriatric Use

Based on available data, no adjustment of the dosage of SEEBRI NEOHALER in geriatric patients is warranted. SEEBRI NEOHALER can be used at the recommended dose in elderly patients 75 years of age and older.

Of the total number of subjects in clinical studies of SEEBRI NEOHALER, 45% were aged 65 and older, while 10% were aged 75 and older. No overall differences in safety or effectiveness were observed between these subjects and younger subjects, and other reported clinical experience has not identified differences in responses between the elderly and younger patients, but greater sensitivity of some older individuals cannot be ruled out.

8.6 Renal Impairment

No dose adjustment is required for patients with mild and moderate renal impairment. SEEBRI NEOHALER should be used in patients with severe renal impairment (estimated GFR less than 30 mL/min/1.73m²), including those with end-stage renal disease requiring dialysis, if the expected benefit outweighs the potential risk since the systemic exposure to glycopyrrolate may be increased in this population [see *Clinical Pharmacology* (12.3)].

8.7 Hepatic Impairment

No dose adjustment is required for patients with hepatic impairment. The effects of hepatic impairment on the pharmacokinetics of glycopyrrolate have not been studied [see *Clinical Pharmacology* (12.3)].

10 OVERDOSAGE

An overdose of glycopyrrolate may lead to anticholinergic signs and symptoms such as nausea, vomiting, dizziness, lightheadedness, blurred vision, increased intraocular pressure (causing pain, vision disturbances, or reddening of the eye), obstipation or difficulties in voiding.

In COPD patients, repeated orally inhaled administration of SEEBRI NEOHALER at total doses of 124.8 and 249.6 mcg once-daily for 28 days were well tolerated.

Accidental ingestion: Acute intoxication by inadvertent oral ingestion of SEEBRI NEOHALER capsules is unlikely due to the low oral bioavailability (about 5%) [see *Clinical Pharmacology* (12.3)].

Peak plasma levels and total systemic exposure following intravenous administration of 150 mcg glycopyrrolate (equivalent to 120 mcg active moiety) in healthy volunteers were respectively about 270-fold and 13-fold higher than the peak and total systemic exposure at steady-state achieved with the recommended daily dose of 31.2 mcg of glycopyrrolate (i.e., 15.6 mcg glycopyrrolate twice-daily) and were well-tolerated.

11 DESCRIPTION

SEEBRI NEOHALER consists of SEEBRI capsules and a NEOHALER device. Each SEEBRI capsule contains a dry powder formulation of glycopyrrolate packaged in orange transparent hypromellose (HPMC) capsules for oral inhalation only with the NEOHALER device.

Each orange transparent HPMC capsule contains 15.6 mcg of glycopyrrolate blended with approximately 25 mg of lactose monohydrate (which contains trace levels of milk protein) and 0.04 mg of magnesium stearate.

Glycopyrrolate, the active component of SEEBRI NEOHALER, is chemically described as (3RS)-3-[(2SR)-(2-cyclopentyl-2-hydroxy-2-phenylacetyl) oxy]-1,1-dimethylpyrrolidinium bromide. This synthetic quaternary ammonium compound acts as a competitive antagonist at muscarinic acetylcholine receptors, also referred to as anticholinergic. Glycopyrrolate, $C_{19}H_{28}BrNO_3$, is a white powder that is freely soluble in water and sparingly soluble in absolute ethanol. It has a molecular mass of 398.33. The structural formula is:

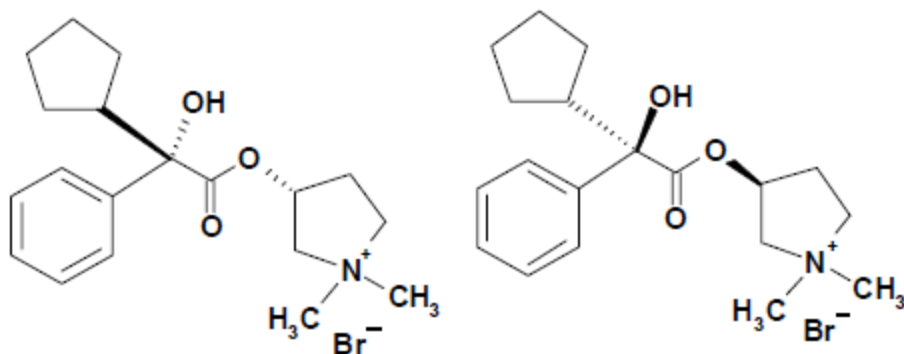

The NEOHALER device is an inhalation device used to inhale the dry powder within the SEEBRI capsule. The amount of drug delivered to the lung will depend on patient factors, such as inspiratory flow rate and inspiratory time. Under standardized in vitro testing at a fixed flow rate of 90 L/min for 1.3 seconds, the NEOHALER device delivered 13.1 mcg for the 15.6 mcg dose strength (equivalent to 12.5 mcg of glycopyrronium) from the mouthpiece. This in vitro testing revealed that the NEOHALER device had a specific resistance of 0.07 cm $H_2O^{1/2}/L/min$. Peak inspiratory flow rates (PIFR) achievable through the NEOHALER device were evaluated in 26 adult patients with COPD of varying severity. Mean PIFR was 95 L/min (range 52 to 133 L/min) for adult patients. Twenty-five of 26 patients (96%) in this study generated a PIFR through the device exceeding 60 L/min.

12 CLINICAL PHARMACOLOGY

12.1 Mechanism of Action

Glycopyrrolate is a long-acting muscarinic antagonist which is often referred to as an anticholinergic. It has similar affinity to the subtypes of muscarinic receptors M1 to M5. In the airways, glycopyrrolate exhibits pharmacological effects through inhibition of M3 receptor at the smooth muscle leading to bronchodilation. The competitive and reversible nature of antagonism was shown with human and animal origin receptors and isolated organ preparations. In preclinical in vitro as well as in vivo studies, prevention of methacholine-induced bronchoconstrictive effects was dose-dependent and lasted longer than 24 hours. The clinical relevance of these findings is unknown. The bronchodilation following inhalation of glycopyrrolate is predominantly a site-specific effect.

12.2 Pharmacodynamics

Cardiac Electrophysiology

The effect of SEEBRI NEOHALER on the QTc interval was evaluated in a Phase 1 randomized placebo and positive controlled double-blind, single-dose, crossover thorough QTc study in 73 healthy subjects. At the dose 16-fold the therapeutic daily dose, SEEBRI NEOHALER did not prolong QTc to any clinically relevant extent.

12.3 Pharmacokinetics

Linear pharmacokinetics of glycopyrrolate was observed following inhalation of daily doses of 31.2 mcg to 249.6 mcg.

Absorption

Following oral inhalation using the NEOHALER inhaler, glycopyrrolate was rapidly absorbed and reached peak plasma levels at 5 minutes post dose.

The absolute bioavailability of glycopyrrolate inhaled via SEEBRI NEOHALER was estimated to be about 40%. About 90% of systemic exposure following inhalation is due to lung absorption and 10% is due to gastrointestinal absorption.

Following repeated once-daily inhalation in patients with COPD, PK steady-state of glycopyrrolate was reached within 1 week of treatment. There was no indication that the glycopyrrolate pharmacokinetics changes over time.

Distribution

After intravenous administration, the steady-state volume of distribution of glycopyrrolate was 83 L and the volume of distribution in the terminal phase was 376 L. The in vitro human plasma protein binding of glycopyrrolate was 38% to 41% at concentrations of 1 to 10 ng/mL.

Metabolism

In vitro metabolism studies show glycopyrrolate hydroxylation resulting in a variety of mono- and bis-hydroxylated metabolites and direct hydrolysis resulting in the formation of a carboxylic acid derivative (M9). Further in vitro investigations showed that multiple CYP isoenzymes contribute to the oxidative biotransformation of glycopyrrolate and the hydrolysis to M9 is likely to be catalyzed by members from the cholinesterase family pre-systemically and/or via first pass metabolism from the swallowed dose fraction of orally inhaled glycopyrrolate. Glucuronide and/or sulfate conjugates of glycopyrrolate were found in urine of humans after repeated inhalation, accounting for about 3% of the dose.

Elimination

Renal elimination of parent drug accounts for about 60% to 70% of total clearance of systemically available glycopyrrolate whereas non-renal clearance processes account for about 30% to 40%. Biliary clearance contributes to the non-renal clearance, but the majority of non-renal clearance is thought to be due to metabolism.

Following inhalation of single and repeated once-daily doses between 62.4 mcg and 249.6 mcg glycopyrrolate by healthy volunteers and patients with COPD, mean renal clearance of glycopyrrolate was in the range of 17.4 L/h and 24.4 L/h indicating active tubular secretion contributes to the renal elimination of glycopyrrolate.

Glycopyrrolate plasma concentrations declined in a multi-phasic manner. The mean terminal elimination half-life was much longer after inhalation (33 to 53 hours) than after intravenous (6.2 hours) and oral (2.8 hours) administration.

Drug Interactions

In vitro inhibition studies demonstrated that glycopyrrolate has no relevant capacity to inhibit CYP1A2, CYP2A6, CYP2B6, CYP2C8, CYP2C9, CYP2C19, CYP2D6, CYP2E1 or CYP3A4/5, the efflux transporters MDR1, MRP2 or MXR, and the uptake transporters OATP1B1, OATP1B3, OAT1, OAT3, OCT1 or OCT2. In vitro enzyme induction studies did not indicate a clinically relevant induction by glycopyrrolate for any of the cytochrome P450 isoenzymes tested as well as for UGT1A1 and the transporters MDR1 and MRP2.

In a clinical study in healthy volunteers, cimetidine, an inhibitor of organic cation transport which is thought to contribute to the renal excretion of glycopyrrolate, increased total systemic exposure (AUC) to glycopyrrolate by 22% and decreased renal clearance by 23%.

Special Populations

Population pharmacokinetic analysis showed no evidence of a clinically relevant effect of age (40 to 85 years) or body weight (45 to 120 kg) on systemic exposure to glycopyrrolate. In addition, there was no evidence of a clinically significant ethnic/race effect (across Caucasian, Chinese, Hispanic/Latino, Japanese subjects). Gender, smoking status, and baseline FEV₁ have no apparent effect on maximal or average glycopyrrolate systemic exposure.

Renal Impairment: Renal impairment has an impact on the systemic exposure to glycopyrrolate. A moderate mean increase in total systemic exposure (AUC_{last}) of up to 1.4-fold was seen in subjects with mild and moderate renal impairment [estimated GFR greater than or equal to 30 mL/min/1.73m²] and up to 2.2-fold in subjects with severe renal

impairment and end stage renal disease [estimated GFR less than 30 mL/min/1.73m²] [see *Use in Specific Populations* (8.6)].

Hepatic Impairment: The effects of hepatic impairment on the pharmacokinetics of glycopyrrolate have not been studied. Glycopyrrolate is cleared predominantly from systemic circulation by renal excretion [see *Use in Specific Populations* (8.7)].

13 NONCLINICAL TOXICOLOGY

13.1 Carcinogenesis, Mutagenesis, Impairment of Fertility

Glycopyrrolate produced no treatment-related increases in the incidence of tumors in a 2-year inhalation study in Wistar rats at inhaled doses up to 0.56 mg/kg/day (approximately 170 times the MRHD in adults on an AUC basis, respectively). A 26-week oral (gavage) study in male and female TgrasH2 mice that received glycopyrrolate at doses up to 93.8 and 125.1 mg/kg/day, respectively, did not show any evidence of tumorigenicity.

Glycopyrrolate tested negative in the following genotoxicity assays: the *in vitro* Ames assay, *in vitro* human lymphocyte chromosomal aberration assay, and *in vivo* rat bone marrow micronucleus assay.

Impairment of fertility was observed in male and female Wistar rats at a subcutaneous dose of 1.88 mg/kg/day (approximately 1900 and 1100 times the MRHD in adults on an AUC basis) based upon findings of decreased implantation sites and live fetuses. No effects on fertility and reproductive performance in male and female rats were observed at a subcutaneous dose of 0.63 mg/kg/day (approximately 350 times the MRHD in adults on an AUC basis).

13.2 Animal Toxicology

Eye findings were observed in Wistar rats at inhaled doses of 0.67 mg/kg/day and higher (approximately 280 times the MRHD in adults on an AUC basis) based upon findings of anterior capsule opacity, prominent anterior suture line, and anterior cataract. No eye findings in Wistar rats were observed at an inhaled dose of 0.09 mg/kg/day (approximately 60 times the MRHD in adults on an AUC basis). Eye findings were observed in beagle dogs at an inhaled dose of 0.33 mg/kg/day (approximately 150 times the MRHD in adults on an AUC basis) based upon findings of conjunctival hyperemia and corneal opacity. No eye findings in beagle dogs were observed at an inhaled dose of 0.12 mg/kg/day (approximately 100 times the MRHD in adults on an AUC basis).

14 CLINICAL STUDIES

The safety and efficacy of SEEBRI NEOHALER were evaluated in a clinical development program that included 2 dose-ranging trials, 4 efficacy and safety trials of 12 weeks duration (placebo-controlled), and a 52-week long-term safety trial. Two of these efficacy and safety trials were conducted in support of the UTIBRON NEOHALER clinical development program, included glycopyrrolate 15.6 mcg BID treatment arms, and are included in the overall safety database. Therefore, the efficacy of SEEBRI NEOHALER is based primarily on the dose-ranging trials in 471 subjects with COPD and the 2 placebo-controlled confirmatory trials in 867 subjects with COPD.

14.1 Dose Ranging Trial

Dose selection for glycopyrrolate in COPD was supported by a 28-day, randomized, double-blind, placebo-controlled, 2-period, crossover study evaluating 7 doses of glycopyrrolate (15.6 mcg, 31.2 mcg, 62.4 mcg, and 124.8 mcg once-daily and 15.6 mcg, 31.2 mcg, and 62.4 mcg twice-daily) or placebo in 388 subjects with COPD. The differences in trough FEV₁ from baseline after 28 days compared to placebo for the 15.6 mcg, 31.2 mcg, 62.4 mcg, and 124.8 mcg once-daily and for 15.6 mcg, 31.2 mcg, and 62.4 mcg twice-daily doses were 0.083 L (95% CI: 0.030, 0.136), 0.098 L (0.048, 0.148), 0.090 L (0.038, 0.142), 0.176 L (0.132, 0.220) 0.139 L (0.089, 0.189), 0.167 L (0.115, 0.219), and 0.177 L (0.132, 0.222), respectively. The dose-ranging results supported the evaluation of glycopyrrolate 15.6 mcg twice-daily in the confirmatory COPD trials.

Figure 1. Adjusted mean change from baseline in FEV₁ (L) over 24 hours on Days 1 and 28

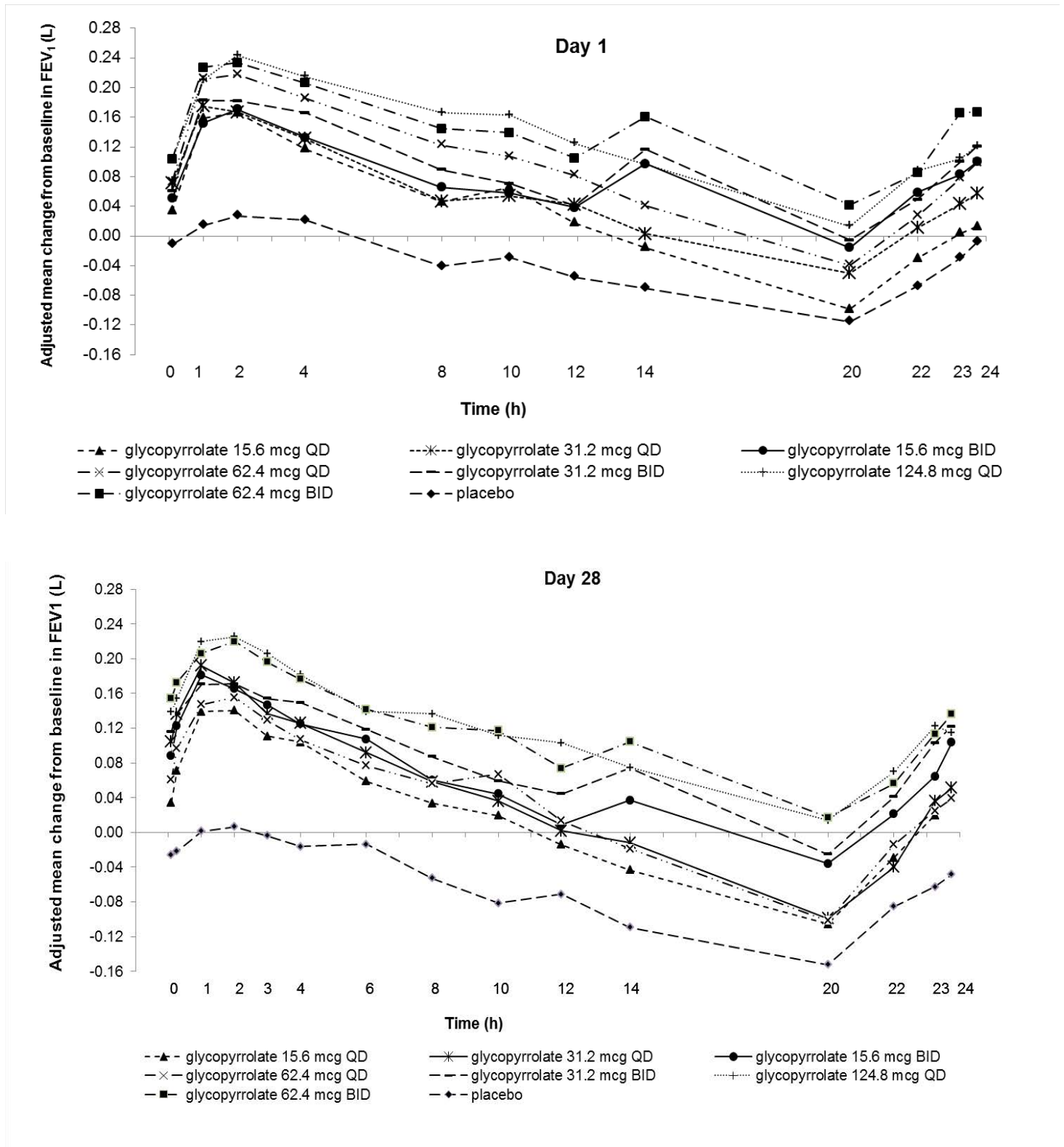

14.2 Confirmatory Trials

The clinical development program for SEEBRI NEOHALER included two (Trial 1 and Trial 2) similar 12-week, randomized, double-blinded, placebo-controlled, parallel-group trials in subjects with COPD designed to evaluate the efficacy of SEEBRI NEOHALER on lung function.

The 12-week trials treated 867 subjects that had a clinical diagnosis of COPD, were 40 years of age or older, had a history of smoking greater than 10 pack-years, had a post-bronchodilator FEV₁ greater than or equal to 30% and less than 80% of

predicted normal values, had a ratio of FEV₁/FVC of less than 0.7, and were symptomatic as determined by a Modified Medical Research Council (mMRC) score greater than or equal to 2. Of the 867 subjects included in the efficacy analysis, 58% were male and 89% were Caucasian. They had a mean age of 63 years and an average smoking history of 53 pack-years, with 57% identified as current smokers, and 29% using inhaled corticosteroids. At screening, the mean post-bronchodilator percent predicted FEV₁ was 55% (range: 30% to 83%), the mean post-bronchodilator percent FEV₁/FVC was 51% (range: 24% to 69%), and the mean percent reversibility was 20% (0% to 169%).

Trial 1 and Trial 2 evaluated SEEBRI NEOHALER (glycopyrrolate) 15.6 mcg twice-daily and placebo twice-daily. The primary endpoint was the change from baseline in FEV₁ AUC_{0-12h} following the morning dose at Day 85 (defined as the mean FEV₁ change from baseline over 0 to 12 hours divided by 12 hours) compared with placebo. In both trials, SEEBRI NEOHALER twice-daily demonstrated a larger increase in mean change from baseline in FEV₁ AUC_{0-12h} compared to placebo (see Table 2).

Table 2. Least Squares (LS) mean change from baseline in FEV₁ (L) AUC_(0-12h) at Day 85 in Trials 1 and 2 (Intent-to-Treat Population)

Treatment	N	Change from baseline LS Mean (SE)	Comparison	Treatment difference LS Mean (SE)	(95% CI)
Trial 1					
SEEBRI NEOHALER	222	0.125 L (0.0162)	SEEBRI NEOHALER - Placebo	0.139 L (0.0225)	(0.095, 0.184)
Placebo	216	-0.014 L (0.0165)			
Trial 2					
SEEBRI NEOHALER	215	0.115 L (0.0153)	SEEBRI NEOHALER - Placebo	0.123 L (0.0213)	(0.081, 0.165)
Placebo	213	-0.008 L (0.0153)			

In Trial 1 and Trial 2, serial spirometric evaluations throughout the 12-hour dosing interval were performed in all subjects at Days 1 and 85. The spirometric curves from Trial 1 at Days 1 and 85 are displayed in Figure 2. In Trial 2, the results for SEEBRI NEOHALER in FEV₁ AUC_{0-12h} were similar to those observed in Trial 1.

Figure 2. Adjusted mean change from baseline in FEV₁ (L) over 12 hours on Days 1 and 85 in Trial 1 (All Patient Population)

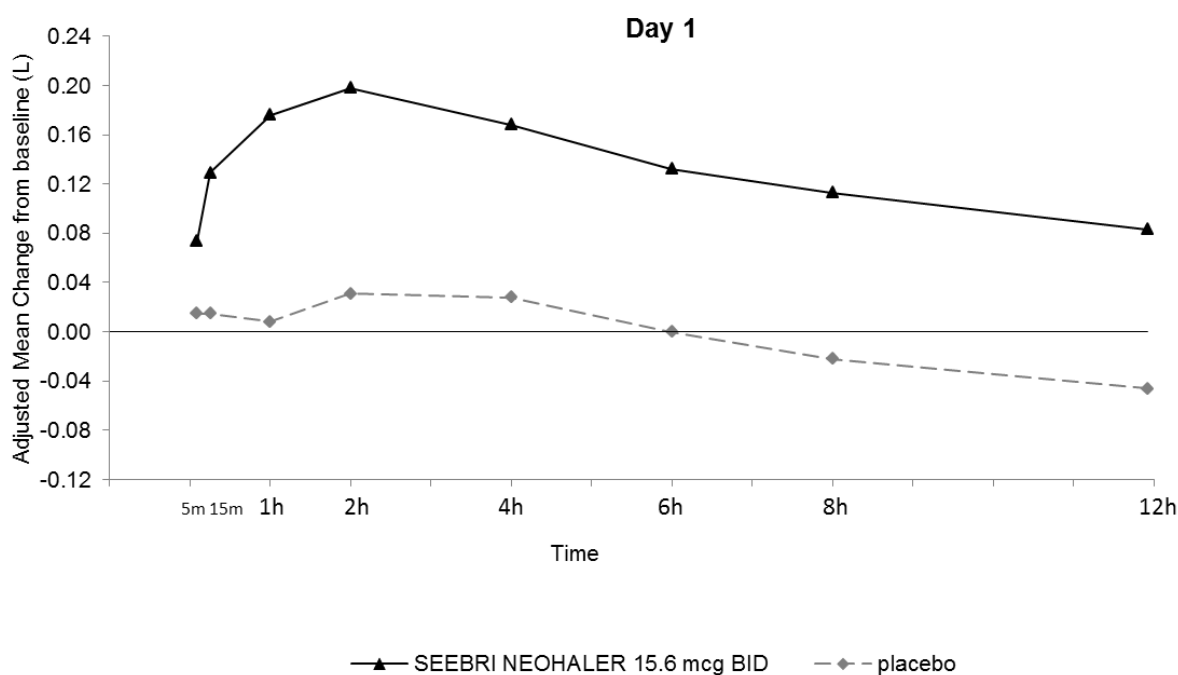

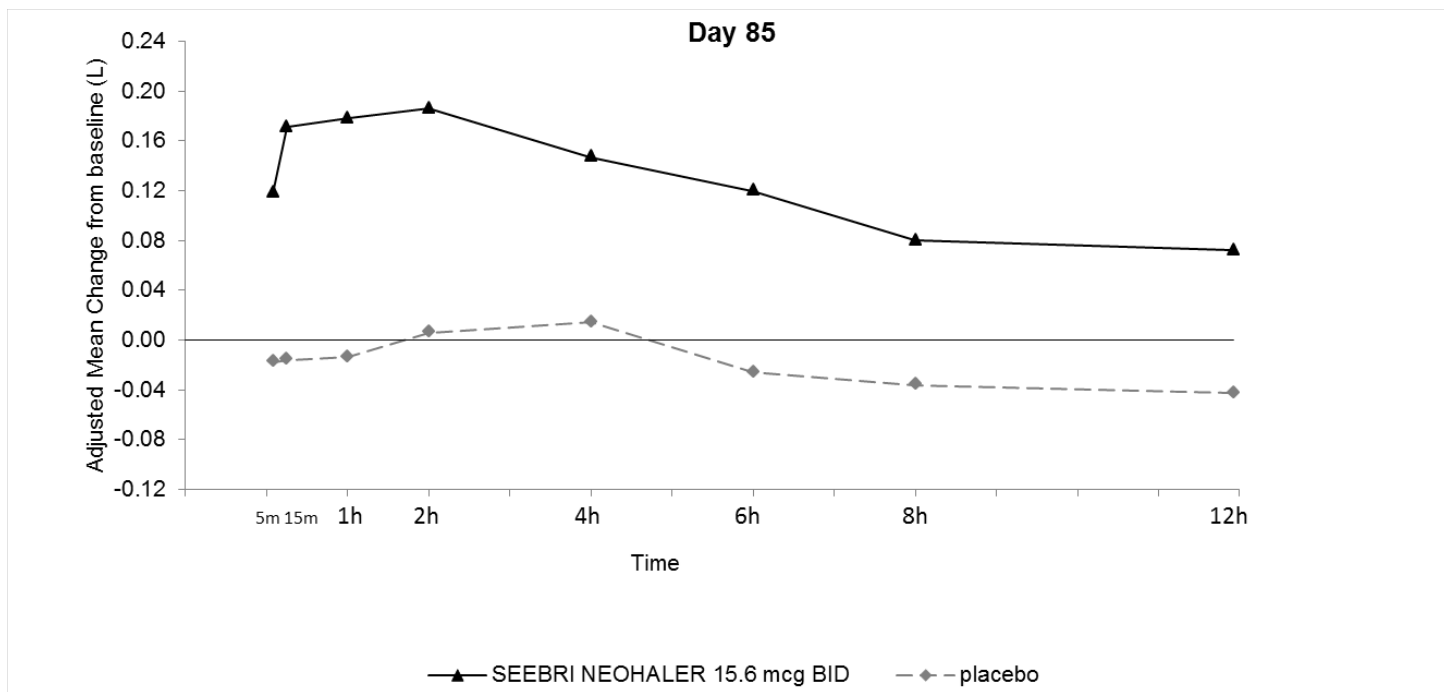

The peak FEV₁ was defined as the maximum FEV₁ recorded within 4 hours after the morning dose on Days 1 and 85. The mean peak FEV₁ improvement from baseline for SEEBRI NEOHALER compared with placebo at Day 1 and at Day 85 was 0.142L and 0.163L (Trial 1), and 0.137L and 0.148L (Trial 2), respectively.

In Trials 1 and 2, patients treated with SEEBRI NEOHALER used less daily rescue albuterol during the trial compared to patients treated with placebo.

The St. George's Respiratory Questionnaire (SGRQ) was assessed in Trials 1 and 2. In Trial 1, the SGRQ responder rate (defined as an improvement in score of 4 or more as threshold) for the SEEBRI NEOHALER treatment arm was 49% compared to 41% for placebo [Odds Ratio: 1.43, 95% CI: 0.95, 2.15]. In Trial 2, the SGRQ responder rate for the SEEBRI NEOHALER treatment arm was 55% compared to 42% for placebo [Odds Ratio: 1.78; 95% CI: 1.17, 2.71].

16 HOW SUPPLIED/STORAGE AND HANDLING

How Supplied

SEEBRI NEOHALER contains SEEBRI (glycopyrrolate (15.6 mcg) inhalation powder) orange transparent capsules packaged in aluminium blister cards, one NEOHALER device, and FDA approved Patient Labeling.

Unit Dose (blister pack), Box of 60 (10 blister cards with 6 orange transparent capsules each) NDC 0078-0662-19

The NEOHALER device consists of a white protective cap and a base with mouthpiece, capsule chamber and 2 orange push buttons.

Storage and Handling

Store in a dry place at 77°F (25°C); excursions permitted to 59°F to 86°F (15°C to 30°C) [see USP Controlled Room Temperature].

- SEEBRI capsules should be used with the NEOHALER device only. Do not use the NEOHALER device with any other capsules.
- Store SEEBRI capsules in the blister protected from moisture. Remove the SEEBRI capsules from the blister immediately before use.
- Always use the new NEOHALER inhaler provided with each new prescription.

Keep out of the reach of children.

17 PATIENT COUNSELING INFORMATION

Advise the patient to read the FDA-approved patient labeling (Patient Information and Instructions for Use).

Not for Acute Symptoms

Inform patients that SEEBRI NEOHALER is not meant to relieve acute symptoms of COPD and extra doses should not be used for that purpose. Advise them to treat acute symptoms with a rescue inhaler such as albuterol. Provide patients with such medicine and instruct them in how it should be used [*see Warnings and Precautions (5.1)*].

Instruct patients to seek medical attention immediately if they experience any of the following:

- Symptoms get worse
- Need for more inhalations than usual of their rescue inhaler

Patients should not stop therapy with SEEBRI NEOHALER without physician/healthcare provider guidance since symptoms may recur after discontinuation.

Paradoxical Bronchospasm

Inform patients that, SEEBRI NEOHALER can produce paradoxical bronchospasm. Advise patients that if paradoxical bronchospasm occurs, patients should discontinue SEEBRI NEOHALER.

Worsening of Narrow-Angle Glaucoma

Instruct patients to be alert for signs and symptoms of acute narrow-angle glaucoma (e.g. eye pain or discomfort, blurred vision, visual halos or colored images in association with red eyes from conjunctival congestion and corneal edema). Instruct patients to consult a physician immediately should any of these signs or symptoms develop.

Worsening of Urinary Retention

Instruct patients to be alert for signs and symptoms of urinary retention (e.g. difficulty passing urine, painful urination). Instruct patients to consult a physician immediately should any of these signs or symptoms develop.

Instructions for Administering SEEBRI NEOHALER

It is important for patients to understand how to correctly administer SEEBRI capsules using the NEOHALER device [*see Instructions for Use*]. Instruct patients that SEEBRI capsules should only be administered via the NEOHALER device and the NEOHALER device should not be used for administering other medications. **Remind patients that the contents of SEEBRI capsules are for oral inhalation only and must not be swallowed.**

Instruct patients always to store SEEBRI capsules in sealed blisters and to only remove a SEEBRI capsule immediately before use or it may not be as effective. Instruct patients to discard unused additional SEEBRI capsules that are exposed to air (i.e., not intended for immediate use).

Inform patients to use one inhalation of SEEBRI NEOHALER orally twice-daily (1 capsule in the morning and 1 capsule in the evening) at the same time every day.

Inform patients that if they miss a dose of SEEBRI NEOHALER, they should use their next capsule at the usual time. Instruct patients to not use 2 capsules at one time and to not use more than 2 capsules in a day.

Distributed by:

Novartis Pharmaceuticals Corporation
East Hanover, New Jersey 07936

© Novartis

T20XX-XX
October 2015

PATIENT INFORMATION
SEEBRI™ NEOHALER®
(SEE-Bri)
(glycopyrrolate)
inhalation powder, for oral inhalation use

Important: Do not swallow SEEBRI capsules. SEEBRI capsules are used only with the NEOHALER inhaler that comes with SEEBRI NEOHALER. Do not place a capsule in the mouthpiece of the NEOHALER inhaler.

Read this Patient Information that comes with SEEBRI NEOHALER before you start using it and each time you get a refill. There may be new information. This Patient Information does not take the place of talking to your healthcare provider about your medical condition or treatment.

What is SEEBRI NEOHALER?

SEEBRI NEOHALER is an anticholinergic medicine known as glycopyrrolate.

- Anticholinergic medicines such as SEEBRI NEOHALER help the muscles around the airways in your lungs stay relaxed to prevent symptoms such as wheezing, coughing, chest tightness, and shortness of breath. This makes it hard to breathe.
- SEEBRI NEOHALER is used for maintenance treatment of Chronic Obstructive Pulmonary Disease (COPD). COPD is a chronic lung disease that includes chronic bronchitis, emphysema, or both.
- SEEBRI NEOHALER is for long-term use and should be taken 2 times each day to improve symptoms of COPD for better breathing.
- **SEEBRI NEOHALER is not used to treat sudden symptoms of COPD.** Always have a short-acting beta₂-agonist medicine (rescue inhaler) with you to treat sudden symptoms of COPD. If you do not have a rescue inhaler, contact your healthcare provider to have one prescribed for you.
- **SEEBRI NEOHALER should not be used in children.** It is not known if SEEBRI NEOHALER is safe and effective in children younger than 18 years of age.

Who should not use SEEBRI NEOHALER?

Do not use SEEBRI NEOHALER if you:

- are allergic to glycopyrrolate, or any of the ingredients in SEEBRI NEOHALER. Ask your healthcare provider if you are not sure. **See “What are the ingredients in SEEBRI NEOHALER?”** at the end of this leaflet for a complete list of ingredients in SEEBRI NEOHALER.

What should I tell my healthcare provider before using SEEBRI NEOHALER?

Before you use SEEBRI NEOHALER, tell your healthcare provider if you:

- have kidney problems.
- have eye problems such as glaucoma. SEEBRI NEOHALER may make your glaucoma worse.
- have prostate or bladder problems, or problems passing urine. SEEBRI NEOHALER may make these problems worse.
- have any other medical conditions.
- are pregnant or plan to become pregnant. It is not known if SEEBRI NEOHALER can harm your unborn baby.
- are breastfeeding or plan to breastfeed. It is not known if the medicine in SEEBRI NEOHALER passes into your breast milk and if it can harm your baby. You and your healthcare provider should decide if you will take SEEBRI NEOHALER or breastfeed.
- are allergic to SEEBRI NEOHALER or any of its ingredients, any other medicines, or food products.

SEEBRI NEOHALER contains lactose (milk sugar) and small amount of milk proteins. It is possible that allergic reactions may happen in people who have a severe milk protein allergy.

Tell your healthcare provider about all the medicines you take, including prescription medicines, over-the-counter medicines, vitamins, and herbal supplements. SEEBRI NEOHALER may affect the way other medicines work, and other medicines can affect how SEEBRI NEOHALER works. Using SEEBRI NEOHALER with other medicines may cause serious side effects.

Especially tell your healthcare provider if you take anticholinergics (including umeclidinium, tiotropium, ipratropium, acclidinium, glycopyrrolate).

Know the medicines you take. Keep a list of your medicines with you and show it to your healthcare provider and pharmacist when you get a new medicine.

How should I use SEEBRI NEOHALER?

Read the **step-by-step instructions for using SEEBRI NEOHALER at the end of this Patient Information.**

- **Do not** use SEEBRI NEOHALER unless your healthcare provider has taught you how to use the inhaler and you understand how to use it correctly.
- Use SEEBRI NEOHALER exactly as your healthcare provider tells you to use it. **Do not** use SEEBRI NEOHALER more often than prescribed for you.
- **Do not swallow SEEBRI capsules.** Only use SEEBRI capsules with the NEOHALER inhaler.
- **Use 1 SEEBRI capsule inhaled through the NEOHALER inhaler 2 times each day (1 capsule in the morning and 1 capsule in the evening).**
- To make sure the full dose has been taken, you should open the inhaler to check that there is no powder left in the capsule. As long as the capsule is empty, you have received 1 full dose.
- If you miss a dose of SEEBRI NEOHALER, take it as soon as you remember. Take your next dose at your usual time.
 - Do not use 2 capsules at 1 time.
 - Do not use more than 2 capsules in a day.
- SEEBRI capsules should always be stored in the blister strip and only removed immediately before use. Peel the backing foil away from the blister to open it, **do not** push the capsule through the foil.
- Always use the new NEOHALER inhaler that is provided with each new prescription.
- **SEEBRI NEOHALER does not relieve sudden symptoms of COPD.** Always have a rescue inhaler medicine with you to treat sudden symptoms. If you do not have a rescue inhaler medicine, call your healthcare provider to have a rescue inhaler prescribed for you.
- **Do not** stop using SEEBRI NEOHALER or other medicines to control or treat your COPD unless told to do so by your healthcare provider because your symptoms might get worse. Your healthcare provider will change your medicines as needed.
- **Call your healthcare provider or get emergency medical care right away** if your breathing problems worsen with SEEBRI NEOHALER, you need to use your rescue medicine more often than usual, or your rescue inhaler medicine does not work as well for you at relieving your symptoms.

What are the possible side effects of SEEBRI NEOHALER?

SEEBRI NEOHALER can cause serious side effects, including:

- **sudden shortness of breath immediately after use of SEEBRI NEOHALER. Sudden shortness of breath may be life-threatening.** If you have sudden breathing problems immediately after inhaling your medicine, stop taking SEEBRI NEOHALER and call your healthcare provider or go to the nearest hospital emergency room right away.
- **serious allergic reactions.** Stop using SEEBRI NEOHALER and call your healthcare provider or get emergency medical care right away if you get any of the following symptoms of a serious allergic reaction:
 - rash
 - hives
 - swelling of the tongue, lips, and face
 - difficulty breathing or swallowing
- **new or worsened eye problems including acute narrow-angle glaucoma.** Acute narrow-angle glaucoma can cause permanent loss of vision if not treated. Symptoms of acute narrow-angle glaucoma may include:
 - eye pain or discomfort
 - nausea or vomiting
 - blurred vision
 - seeing halos or bright colors around lights
 - red eyes

If you have these symptoms, stop taking SEEBRI NEOHALER and call your healthcare provider right away before using another dose.

- **new or worsened urinary retention.** People who use SEEBRI NEOHALER may develop new or worse urinary retention. Urinary retention can be caused by a blockage in your bladder. Urinary retention can also happen in men who have a larger than normal prostate. Symptoms of urinary retention may include:
 - difficulty urinating
 - painful urination
 - urinating frequently
 - urination in a weak stream or drips

If you have these symptoms, stop taking SEEBRI NEOHALER and call your healthcare provider right away before taking another dose.

Common side effects of SEEBRI NEOHALER include upper respiratory tract infection, sore throat and runny nose.

Tell your healthcare provider about any side effect that bothers you or that does not go away.

These are not all of the possible side effects of SEEBRI NEOHALER. For more information, ask your healthcare provider or pharmacist.

Call your doctor or pharmacist for medical advice about side effects. You may report side effects to FDA at 1-800-FDA-1088.

How should I store SEEBRI NEOHALER?

- Store SEEBRI NEOHALER (inhaler and blister-packaged capsules) at room temperature between 68°F to 77°F (20°C to 25°C).
- **Do not** remove SEEBRI capsules from the blister card it comes in until you are ready to use a dose of SEEBRI NEOHALER.
- **Do not** store SEEBRI capsules in the NEOHALER inhaler.
- Keep SEEBRI NEOHALER in a dry place away from moisture.
- **Keep SEEBRI NEOHALER and all medicines out of the reach of children.**

General information about the safe and effective use of SEEBRI NEOHALER.

Medicines are sometimes prescribed for purposes other than those listed in the Patient Information. **Do not** use SEEBRI NEOHALER for a condition for which it was not prescribed. **Do not** give SEEBRI NEOHALER to other people, even if they have the same symptoms you have. It may harm them.

This Patient Information summarizes the most important information about SEEBRI NEOHALER. If you would like more information, talk with your healthcare provider or pharmacist. You can ask your healthcare provider or pharmacist for information that was written for healthcare professionals.

For more information about SEEBRI NEOHALER or to report side effects, go to www.Seebri.com or call 1-888-669-6682.

What are the ingredients in SEEBRI NEOHALER?

Active ingredient: glycopyrrolate

Inactive ingredients: lactose monohydrate (contains milk proteins) and magnesium stearate.

Distributed by:
Novartis Pharmaceuticals Corporation
East Hanover, New Jersey 07936

© Novartis

T201X-XX

This Patient Information has been approved by the U.S. Food and Drug Administration.

October 2015

Instructions for Use
SEEBRI™ NEOHALER®
(SEE-Bri)
(glycopyrrolate)
inhalation powder, for oral inhalation use

For Oral Inhalation Only

Do not swallow SEEBRI capsules.



Follow the instructions below for using SEEBRI NEOHALER. You will breathe-in (inhale) the medicine in the SEEBRI capsules from the NEOHALER inhaler. If you have any questions, **ask your healthcare provider or pharmacist.**

Your SEEBRI NEOHALER

SEEBRI NEOHALER consists of both the inhaler and the blister-packaged capsules. Each package contains SEEBRI capsules and a NEOHALER inhaler.

- (1) NEOHALER inhaler which consists of a cap and a base (see figure below)
- SEEBRI capsules come in blister cards to be used only in the NEOHALER inhaler (see figure below)

Your inhaler is made to give you the medicine contained in the capsules.

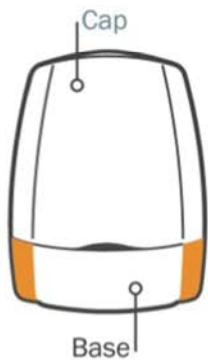

Inhaler

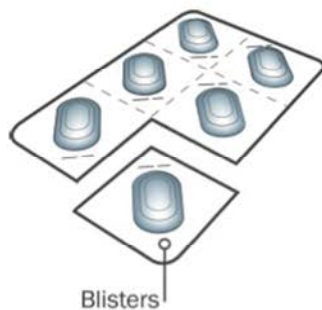

Blister card

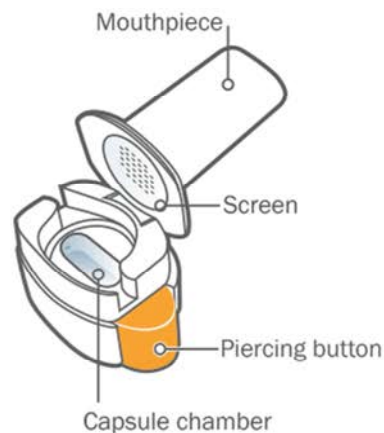

Only use the NEOHALER inhaler contained in this pack. Do not use SEEBRI NEOHALER capsules with any other inhaler, do not use NEOHALER inhaler to take any other capsule medicine.

How to use your inhaler:



Step 1. Pull off cap.



Step 2. Open inhaler:

Hold the base of the inhaler firmly and tilt the mouthpiece to open the inhaler.

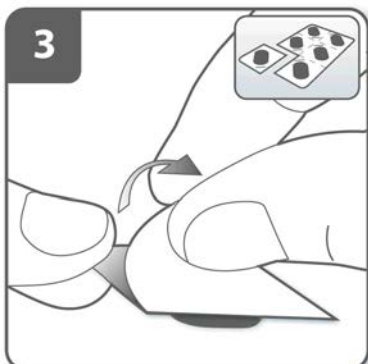

Step 3. Prepare capsule:

Separate 1 of the blisters from the blister card by tearing along the perforation.

Take 1 blister and peel away the protective backing to expose the capsule.

Do not push the capsule through the foil to remove it from the blister.

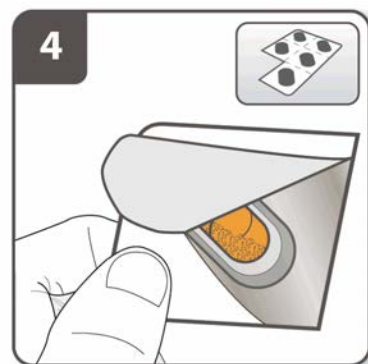

Step 4. Remove a SEEBRI capsule:

Capsules should always be stored in the blister and only removed immediately before use.

With dry hands, remove 1 capsule from the blister.

Do not swallow the SEEBRI capsule.



Step 5. Insert capsule:

Place the capsule into the capsule chamber.

Do not place a capsule directly into the mouthpiece.



Step 6. Close the inhaler:

Close the inhaler fully. You should hear a 'click' as it fully closes.

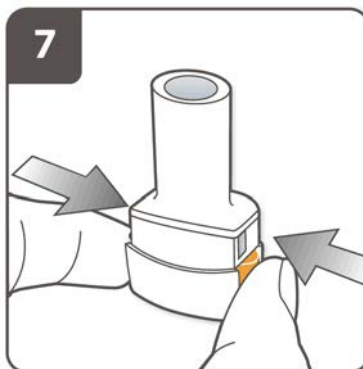

Step 7. Pierce the capsule:

Hold the inhaler upright with the mouthpiece pointing up.

Press both piercing buttons together firmly at the same time. You should hear a 'click' as the capsule is being pierced.

Do not press the piercing buttons more than 1 time.

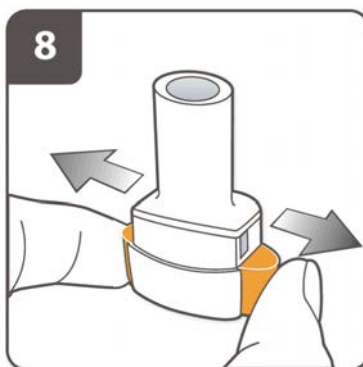

Step 8. Release the piercing buttons fully.

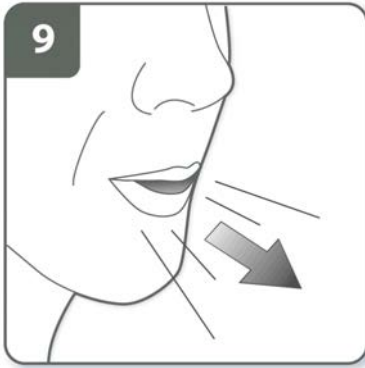

Step 9. Breathe out:

Before placing the mouthpiece in your mouth, breathe out fully.

Do not blow into the mouthpiece.

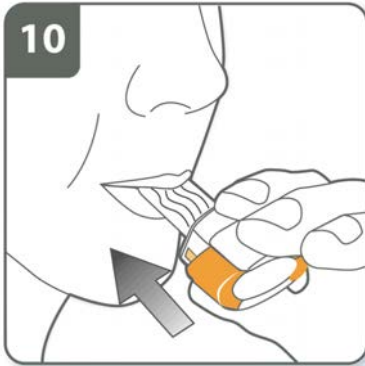

Step 10. Inhale the medicine:

Before breathing in:

- Hold the inhaler as shown in the figure next to Step 10. Make sure that the piercing buttons are to the left and right of the inhaler (not up and down).
- Place the mouthpiece in your mouth and close your lips firmly around the mouthpiece.
- Breathe in rapidly but steadily, as deeply as you can. **Do not press the piercing buttons.**



Step 11. Note:

As you breathe in through the inhaler, the capsule spins around in the chamber and you should hear a whirring noise. You may experience a sweet flavor as you inhale the medicine.

If you do not hear a whirring noise, the capsule may be stuck in the capsule chamber. If this occurs, open the inhaler and carefully loosen the capsule by tapping the base of the inhaler. **Do not press the piercing buttons to loosen the capsule. (Repeat steps 9 and 10 if necessary).**

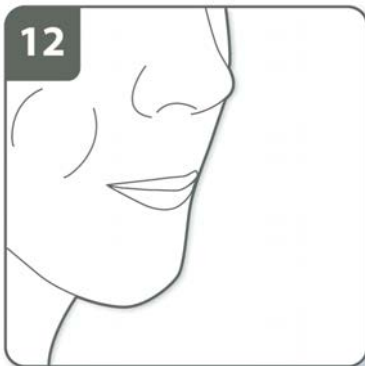

Step 12. Hold breath:

Continue to hold your breath for at least 5 to 10 seconds or as long as comfortably possible while removing the inhaler from your mouth. Then breathe out.

Open the inhaler to see if any powder is left in the capsule. **If there is powder left in the capsule, close the inhaler and repeat steps 9 to 12.** Most people are able to empty the capsule with 1 or 2 inhalations.

Some people may cough soon after inhaling the medicine. If you do, don't worry, as long as the capsule is empty, you have received 1 full dose.

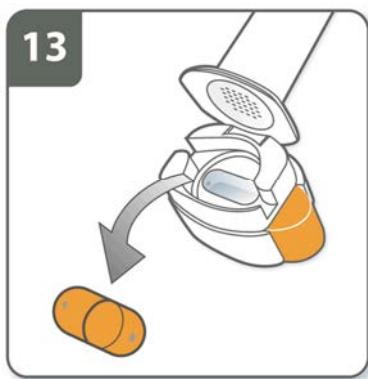

Step 13. Remove capsule:

After you have finished taking your dose of SEEBRI NEOHALER, open the mouthpiece again, remove the empty capsule by tipping it out of the capsule chamber, and throwing it away. Close the inhaler and replace the cap.

Do not leave the used capsules in the NEOHALER inhaler.

Additional Information:

Occasionally, very small pieces of the capsule can get past the screen and enter your mouth. If this happens, you may be able to feel these pieces on your tongue. It is not harmful if these pieces are swallowed or inhaled. **The chances of the capsule shattering (breaking apart) will be increased if the capsule is pierced more than once (see Step 7).** Therefore, it is recommended that you follow the storage directions, remove the capsule from the blister immediately before use and pierce each capsule only once.

How to clean your inhaler:

Cleaning the inhaler device is not necessary, however, if you want to clean your inhaler, wipe the mouthpiece inside and outside with a clean, dry, lint-free cloth, or a clean, dry soft brush may be used to wipe the inhaler between uses to remove any powder residue. Keep the inhaler dry.

REMEMBER:

- **Do not swallow SEEBRI capsules.**
- **Only use the NEOHALER inhaler contained in this pack.**
- **Do not** place a SEEBRI NEOHALER capsule directly into the mouthpiece of the NEOHALER inhaler.
- **Do not** blow into the mouthpiece of the NEOHALER inhaler.
- Always release the piercing buttons before inhalation.
- **Do not** press the piercing buttons more than once.
- **Do not** take the NEOHALER inhaler apart.
- Always use the new NEOHALER inhaler that comes with your new SEEBRI NEOHALER medication pack.
- **Do not** use SEEBRI capsules with inhalers from other medicines.

How should I store SEEBRI NEOHALER?

- Store SEEBRI NEOHALER (inhaler and blister-packaged capsules) at room temperature between 68°F to 77°F (20°C to 25°C).
- **Do not** remove SEEBRI capsules from their blister card it comes in until you are ready to use a dose of SEEBRI NEOHALER.
- **Do not** store SEEBRI capsules in the NEOHALER inhaler.
- Keep SEEBRI NEOHALER in a dry place away from moisture.
- Keep SEEBRI NEOHALER and all medicines out of reach of children.

SEEBRI is a trademark of Novartis AG. NEOHALER is a registered trademark of Novartis AG.

Distributed by:

Novartis Pharmaceuticals Corporation
East Hanover, New Jersey 07936

For more information, go to www.Seebri.com or call 1-888-669-6682.

© Novartis

T20XX-XX

This Instructions for Use has been approved by the U.S. Food and Drug Administration.

October 2015